

Dimensions

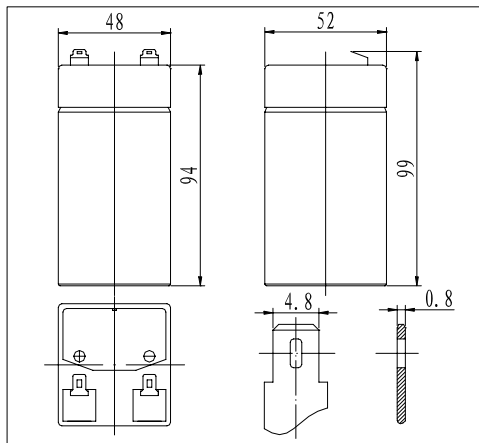

The Relationship for Open Circuit Voltage and Residual Capacity (25°C)

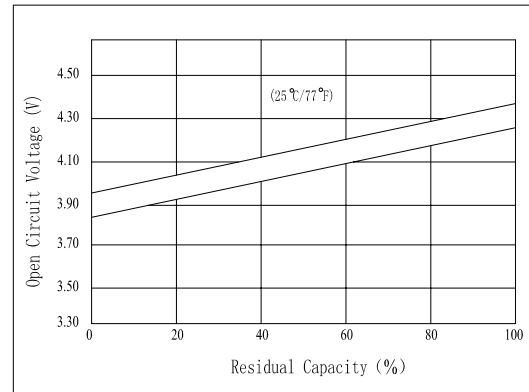

Specifications

Nominal Voltage	4 V	
Capacity(20HR, 25°C)	4.5 Ah	
Dimension	Length	48mm (1.89inch)
	Width	52mm (2.05inch)
	Height	94mm (3.70inch)
	Total Height	99mm (3.90inch)
Approx. Weight	0.55kg (1.21lbs)	
Internal resistance (Fully charged, 25°C)	Approx. 15mΩ	
Capacity affected by temperature (20HR)	40°C	102%
	25°C	100%
	0°C	85%
	-15°C	65%
Self-discharge (25°C)	3 month	Remaining Capacity: 91%
	6 month	Remaining Capacity: 82%
	12 month	Remaining Capacity: 65%
Nominal operating temperature	25°C ± 3°C (77°F ± 5°F)	
Operating temperature range	-15°C ~ 50°C (5°F ~ 122°F)	
Float charging voltage(25°C)	4.50 to 4.60V	
Cyclic charging voltage(25°C)	4.85 to 4.95V	
Maximum charging current	1.35A	
Terminal material	Copper	
Maximum discharge current	68A(5 sec.)	

Charging Characteristics(25°C)

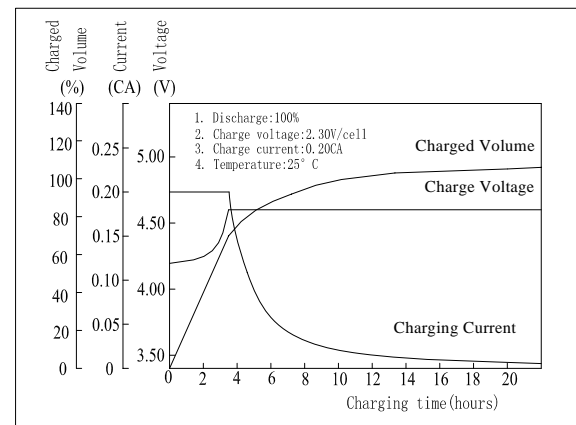

Cycle Life(25°C)

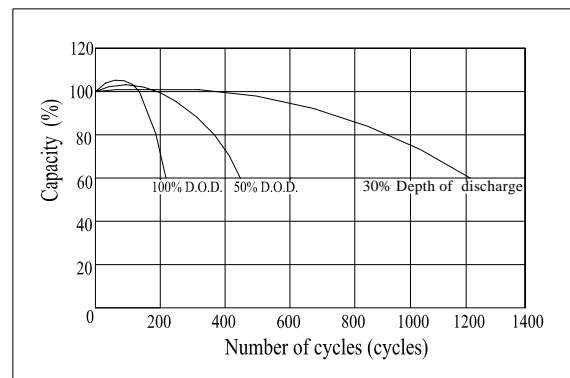

Note: Floating life at 20°C designed for 3 to 5 years.

- ◆ Absorbent glass mat technology;
- ◆ Recognized by UL & CE;
- ◆ ABS container.

Constant Current Discharge Characteristics (A, 25°C)

F.V/TIME	5min	10min	15min	30min	60min	3h	5h	10h	20h
3.20V	16.2	10.8	8.80	4.80	3.10	1.12	0.76	0.45	0.23
3.40V	15.4	10.3	8.45	4.65	3.02	1.10	0.75	0.45	0.23
3.60V	14.5	9.65	8.03	4.47	2.92	1.06	0.74	0.44	0.22

Constant Power Discharge Characteristics (Watt, 25°C)

F.V/TIME	5min	10min	15min	30min	60min	3h	5h	10h	20h
3.20V	60.3	40.6	33.4	18.3	12.0	4.44	3.02	1.80	0.92
3.40V	57.3	38.7	32.1	17.8	11.7	4.36	2.99	1.80	0.92
3.60V	53.9	36.3	30.5	17.1	11.3	4.20	2.95	1.76	0.88